

FASCIA TRIM

- HK0005 - SOFFIT PANEL ERECTION DETAIL
 - HK1010 - CAP TRIM AT FASCIA OR PARAPET
 - HK1020 - FASCIA CORNER DETAIL - A-PANEL
 - HK1030 - FASCIA CORNER DETAIL - R-PANEL
 - HK1040 - FASCIA CORNER DETAIL - REVERSE R-PANEL
 - HK1050 - FASCIA TERMINATION DETAIL - A-PANEL
 - HK1060 - FASCIA TERMINATION DETAIL - R-PANEL
 - HK1070 - FASCIA TERMINATION SECTION - REVERSE R-PANEL
 - HK1080 - FASCIA TERMINATION SECTION - R-PANEL
 - HK1090 - FASCIA CORNER DETAIL - A-PANEL
 - HK1100 - FASCIA CORNER DETAIL - REVERSE R-PANEL
 - HK1110 - FASCIA TERMINATION SECTION - R-PANEL
 - HK1120 - FASCIA TERMINATION SECTION - A-PANEL
 - HK1130 - FASCIA TERMINATION SECTION - REVERSE R-PANEL
 - HK1140 - SOFFIT CORNER TRIM
 - HK1150 - FASCIA CAP TRIM CORNER DETAIL
 - HK1160 - FASCIA TERMINATION DETAIL
 - HK1170 - FASCIA TERMINATION DETAIL
 - HK1180 - FASCIA SOFFIT TERMINATION AT WALL
-

HK0005 - SOFFIT PANEL ERECTION DETAIL

[Download the DWG file by clicking here.](#)

- H1060 STITCH FASTENER
- ▣ H1040 STRUCTURAL FASTENER

ERECTOR NOTE:

ERECTION OF THE SOFFIT PANEL MUST BE COORDINATED PROPERLY WITH THE SOFFIT TRIM CONDITIONS AS SHOWN IN THE ERECTION DETAILS. PLACEMENT AND ORIENTATION OF THE SOFFIT PANEL MAY VARY BY CONDITION AND SUPPORT MEMBERS MAY ALSO VARY. USE THIS FASTENING PATTERN UNLESS TRIM SECTION SHOWS A SPECIFIC PATTERN.

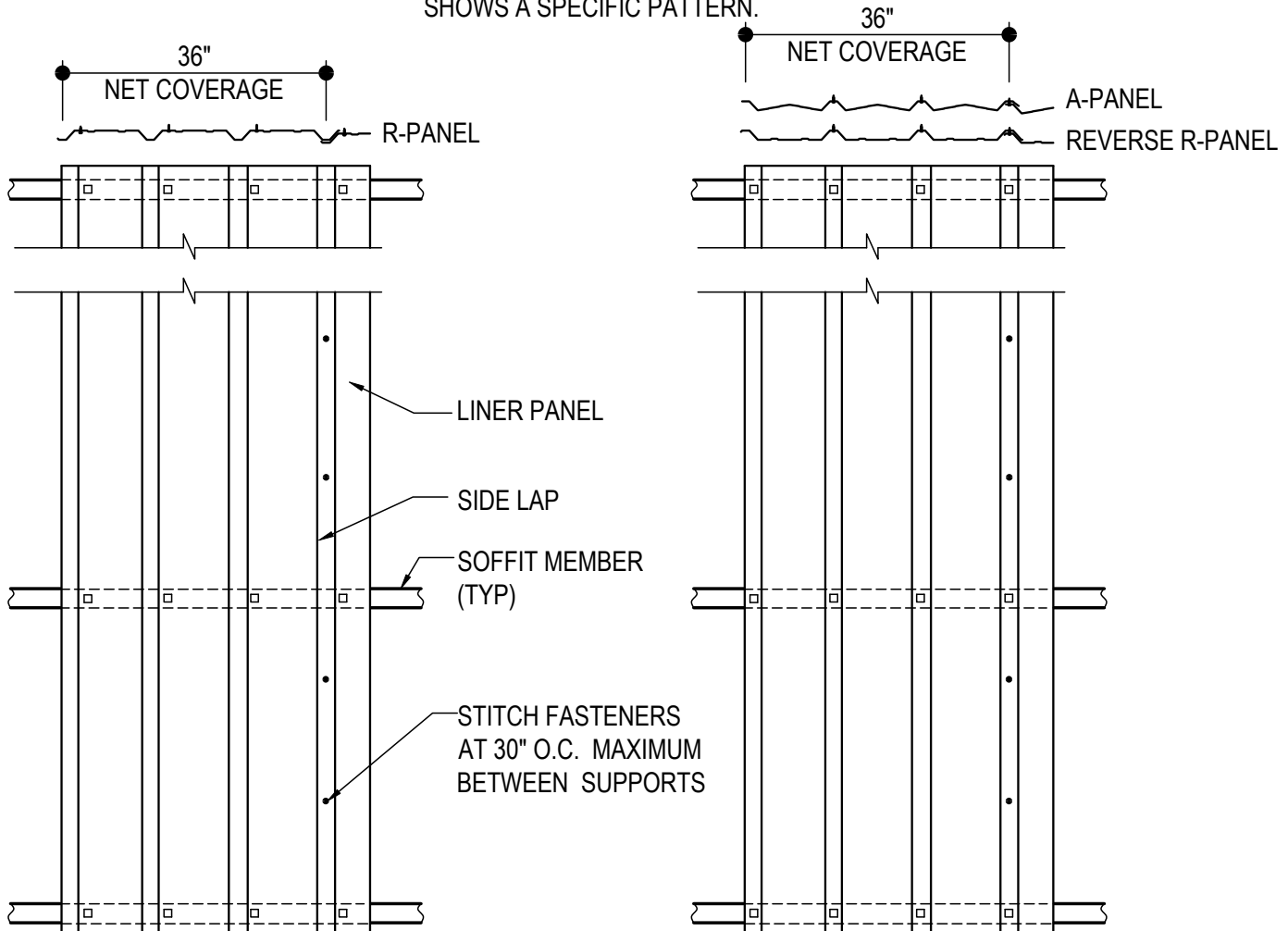

SOFFIT PANEL ERECTION DETAIL

HK0005

Detailer Notes:

- 1) THIS DETAIL IS A DUPLICATE OF DO0005, DQ0005, EO30005, EO60005, EQ3005 & EQ6005. DUPLICATE DETAILS ARE TO ENSURE THAT THEY ARE PLACED IN ORDER IN THE ERECTION DRAWINGS.

HK1010 - CAP TRIM AT FASCIA OR PARAPET

[Download the DWG file by clicking here.](#)

CAP TRIM LAP

APPLY CONTINUOUS BEAD OF CAULK 1" FROM END OF TRIM DOWN PROFILE OF TRIM. FASTEN LAP WITH STITCH FASTENERS AND POP RIVETS AS SHOWN.

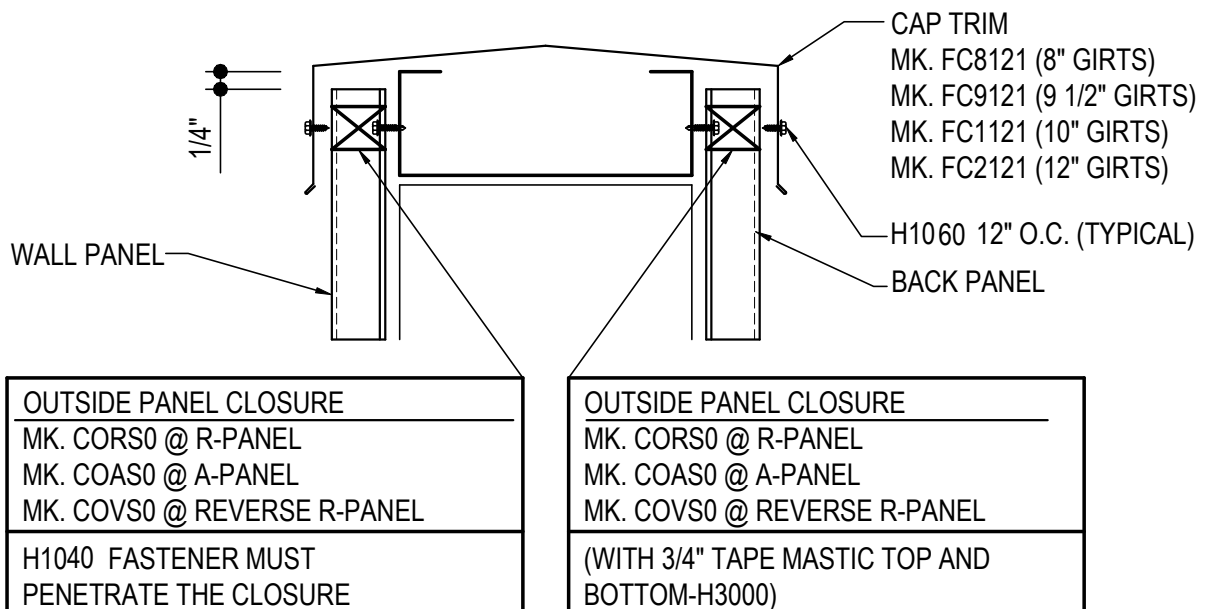
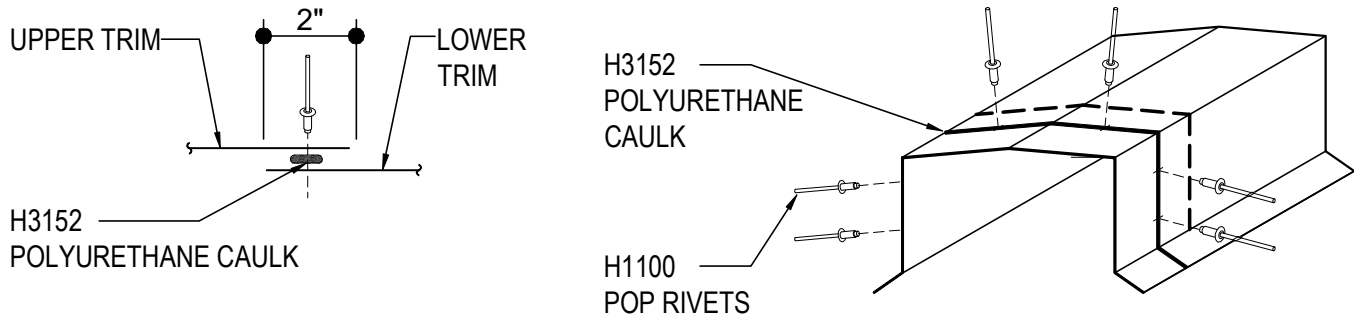

TOP OF PARAPET OR FASCIA

CAP TRIM AT TOP OF PARAPET OR FASCIA WITH STANDARD WALL PANEL

HK1010

Detailer Notes:

- 1) THIS DETAIL IS USED FOR ALL STANDARD WALL PANELS.

HK1020 - FASCIA CONER DETAIL - A-PANEL

[Download the DWG file by clicking here.](#)

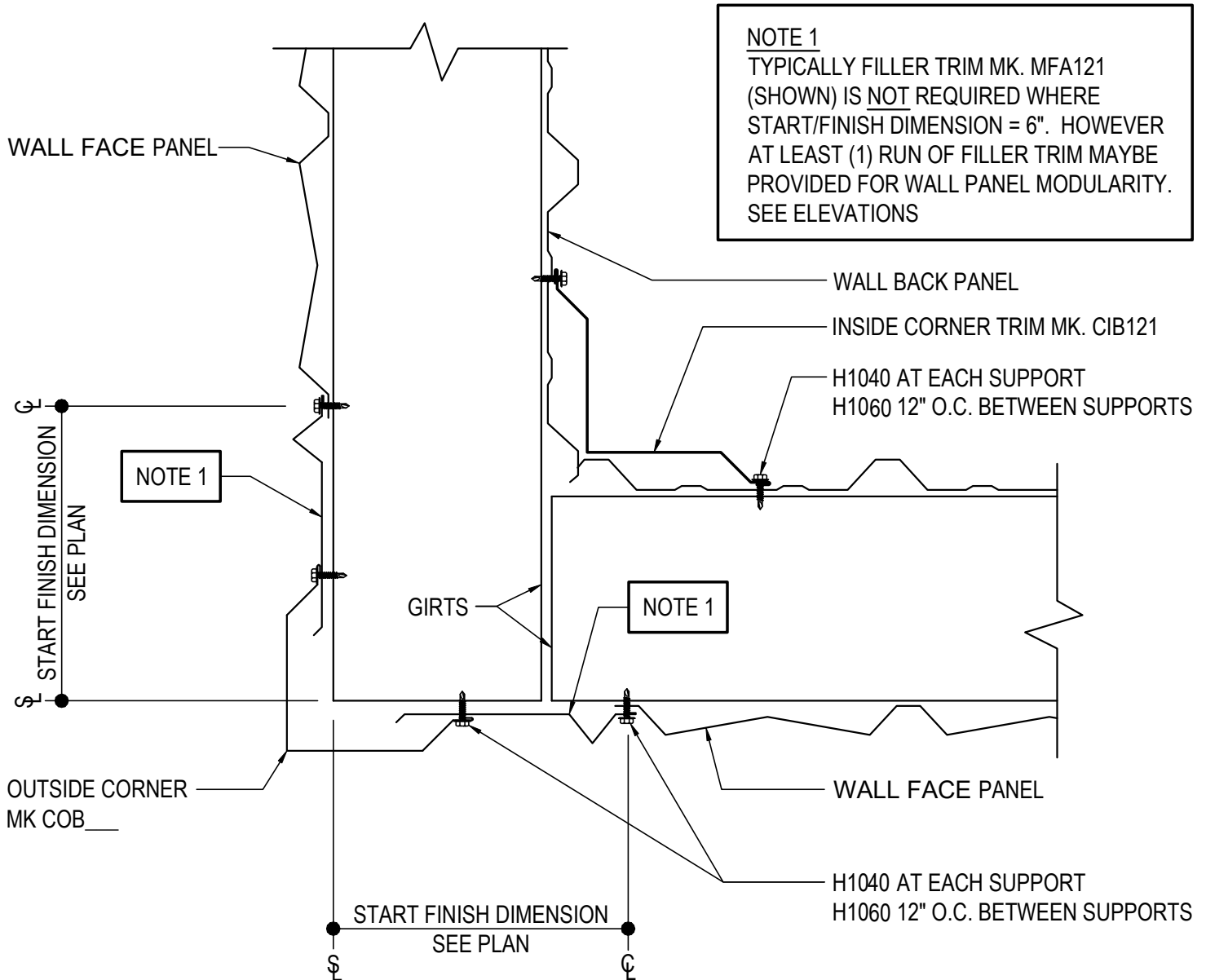

FASCIA CORNER DETAIL

SEE WALL SHEETING ERECTION NOTES FOR WALL PANEL FASTENER LOCATIONS

HK1020

Detailer Notes:

- 1) N/A

HK1030 - FASCIA CONER DETAIL - R-PANEL

[Download the DWG file by clicking here.](#)

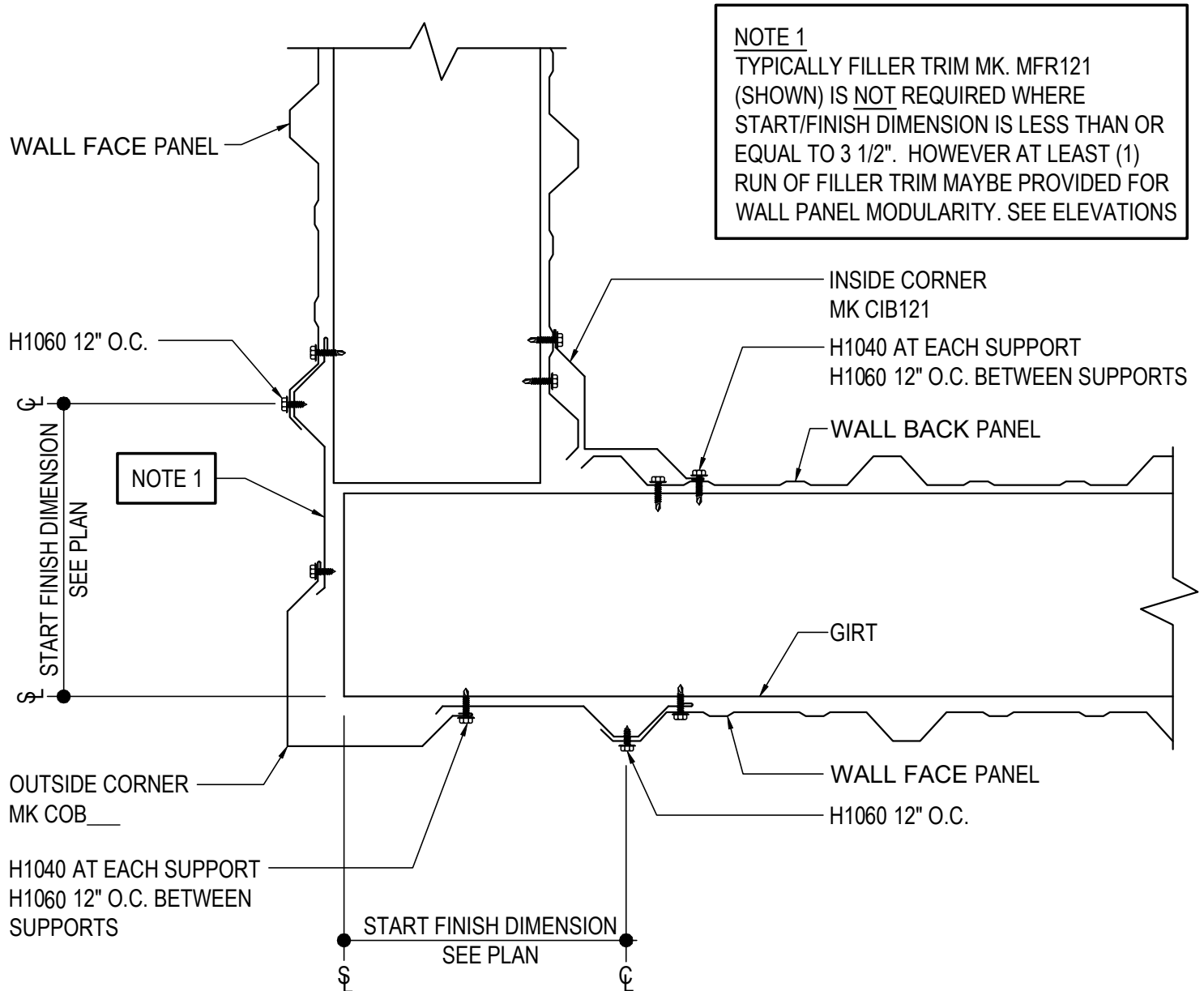

FASCIA CORNER TRIM DETAIL

SEE WALL SHEETING ERECTION NOTES FOR WALL PANEL FASTENER LOCATIONS

HK1030

Detailer Notes:

- 1) N/A

HK1040 - FASCIA CONER DETAIL - REVERSE R-PANEL

[Download the DWG file by clicking here.](#)

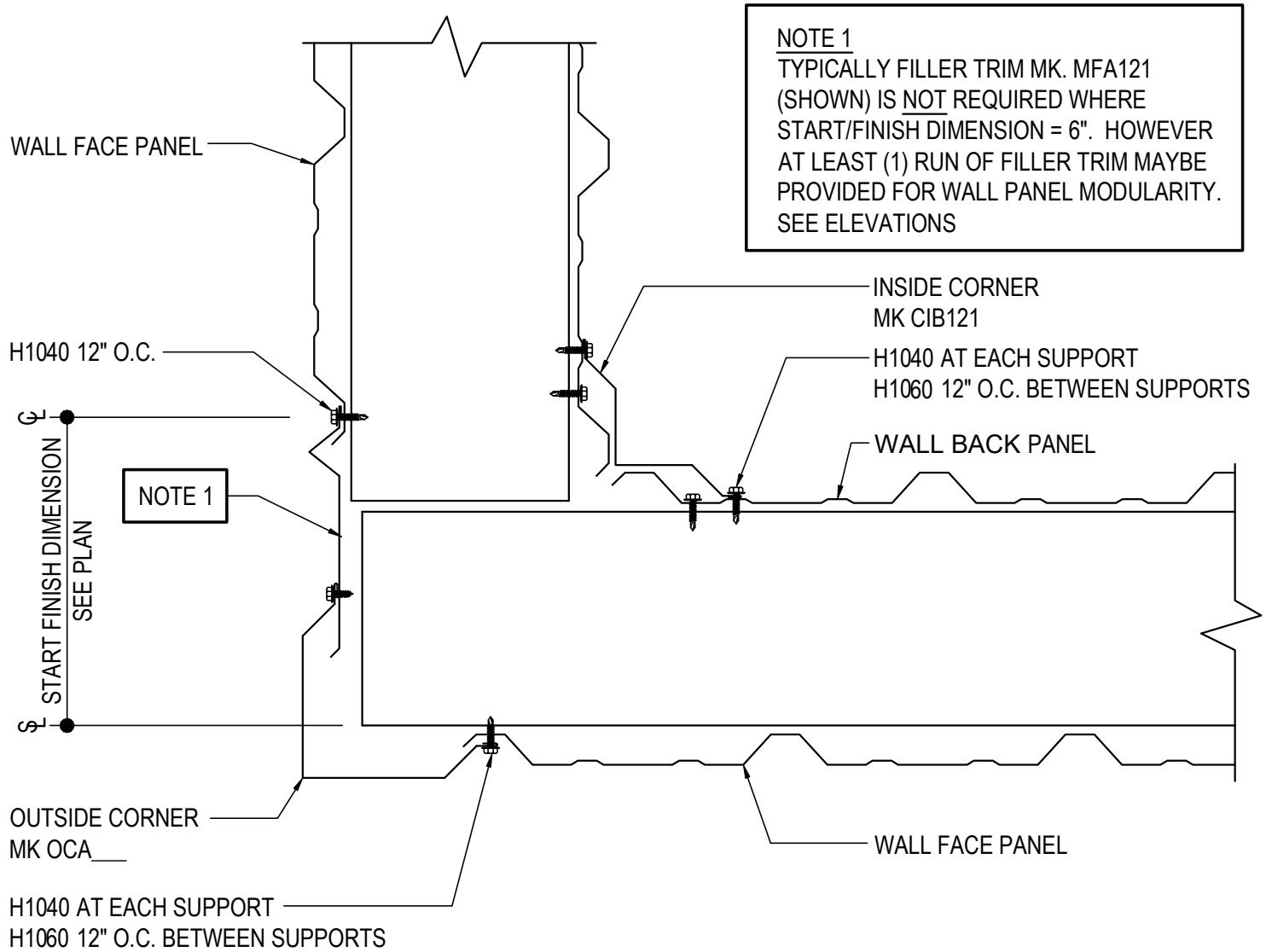

FASCIA CORNER TRIM DETAIL

SEE WALL SHEETING ERECTION NOTES FOR WALL PANEL FASTENER LOCATIONS

HK1040

Detailer Notes:

- 1) N/A

HK1050 - FASCIA TERMINATION DETAIL - A-PANEL

[Download the DWG file by clicking here.](#)

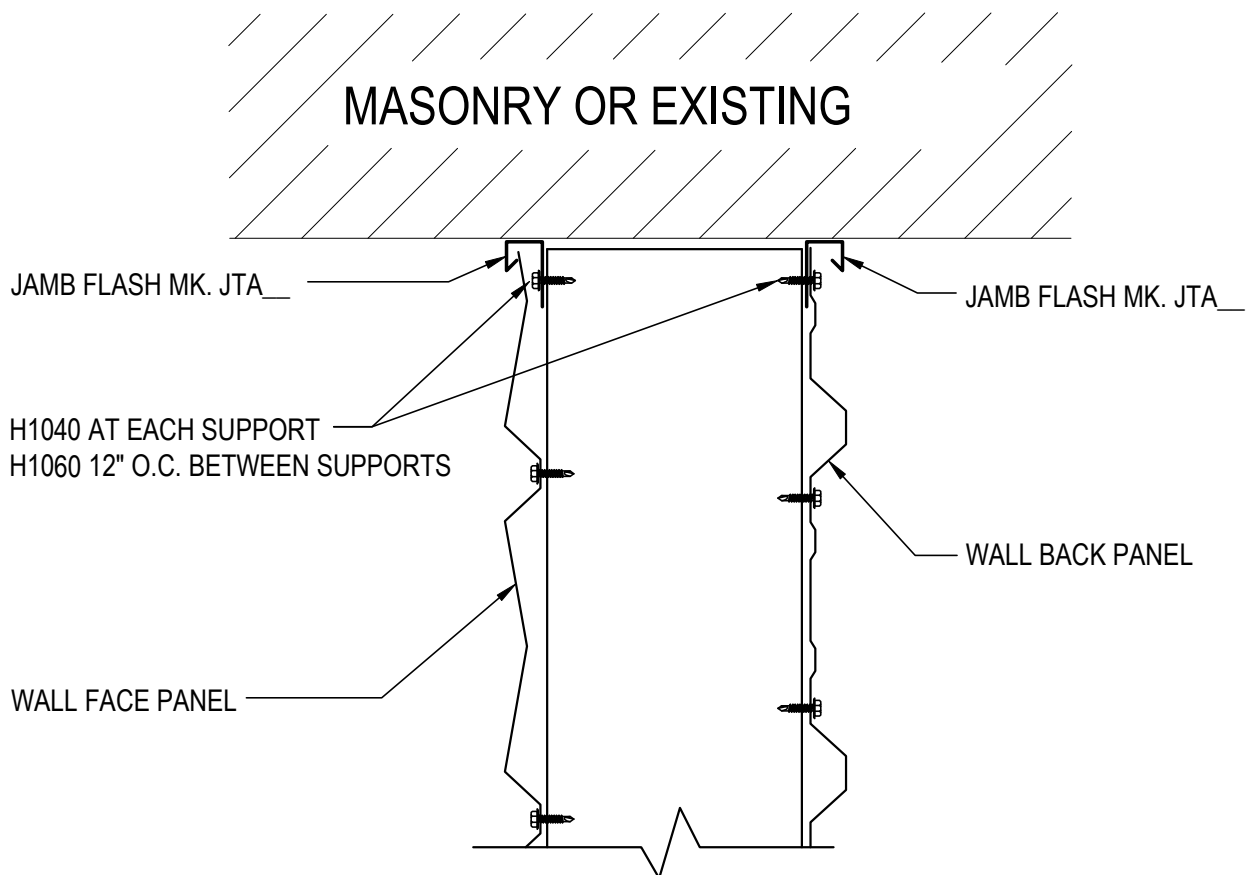

FASCIA TERMINATION DETAIL

SEE WALL SHEETING ERECTION NOTES FOR WALL PANEL FASTENER LOCATIONS

HK1050

Detailer Notes:

- 1) N/A

HK1060 - FASCIA TERMINATION DETAIL - R-PANEL

[Download the DWG file by clicking here.](#)

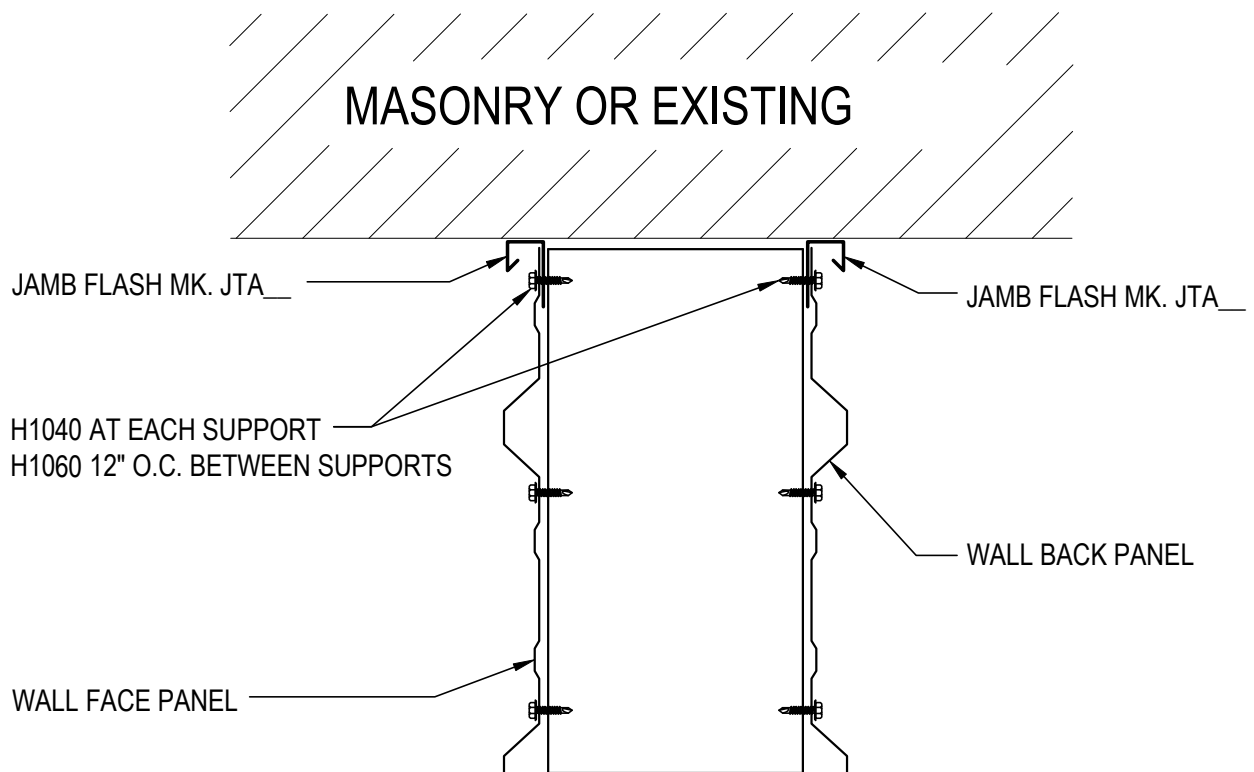

FASCIA TERMINATION DETAIL

SEE WALL SHEETING ERECTION NOTES FOR WALL PANEL FASTENER LOCATIONS

HK1060

Detailer Notes:

- 1) N/A

HK1070 - FASCIA TERMINATION DETAIL - REVERSE R-PANEL

[Download the DWG file by clicking here.](#)

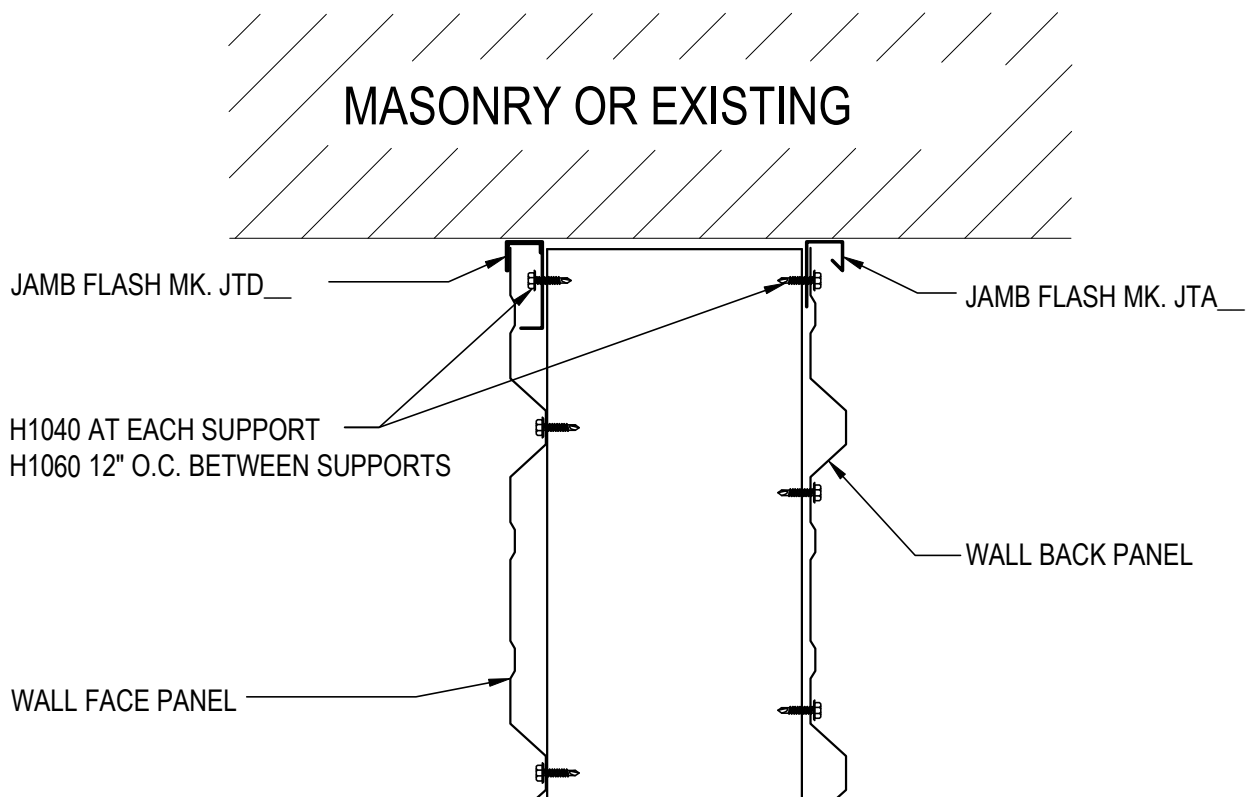

FASCIA TERMINATION DETAIL

SEE WALL SHEETING ERECTION NOTES FOR WALL PANEL FASTENER LOCATIONS

HK1070

Detailer Notes:

1) N/A

HK1080 - FASCIA TERMINATION SECTION - R-PANEL

[Download the DWG file by clicking here.](#)

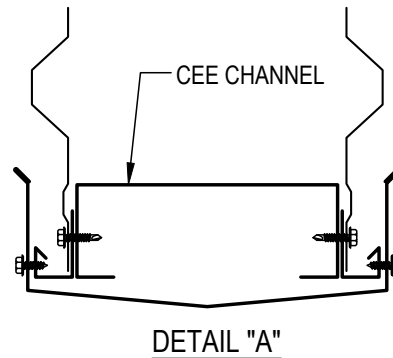

SUPPORT MEMBER MAY BE A CEE CHANNEL IN LIEU OF MAR02 ANGLES. REFER TO FASCIA ELEVATIONS AND FASCIA STRUCTURAL DETAILS.

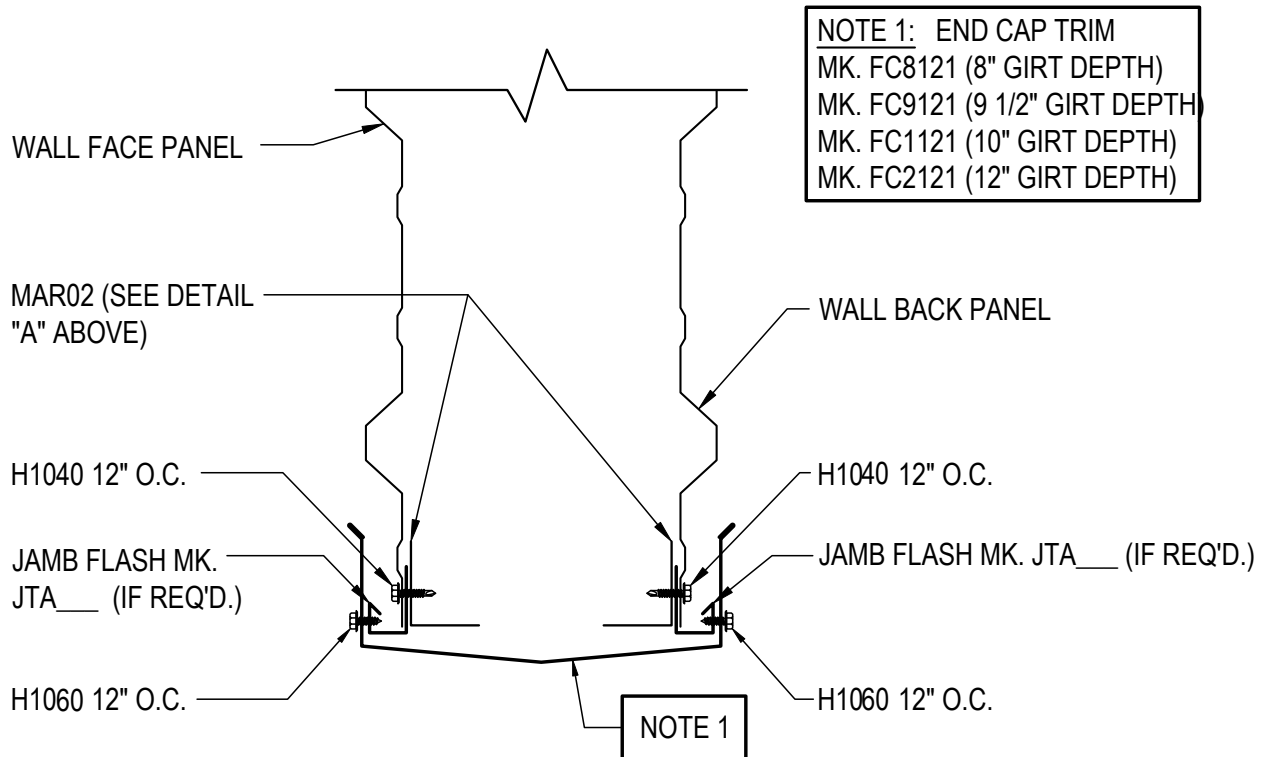

FASCIA TERMINATION SECTION

ABOVE ROOF

HK1080

Detailer Notes:

1) N/A

HK1090 - FASCIA TERMINATION SECTION - A-PANEL

[Download the DWG file by clicking here.](#)

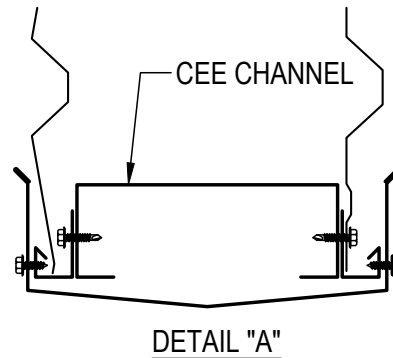

SUPPORT MEMBER MAY BE A CEE CHANNEL IN LIEU OF MAR02 ANGLES. REFER TO FASCIA ELEVATIONS AND FASCIA STRUCTURAL DETAILS.

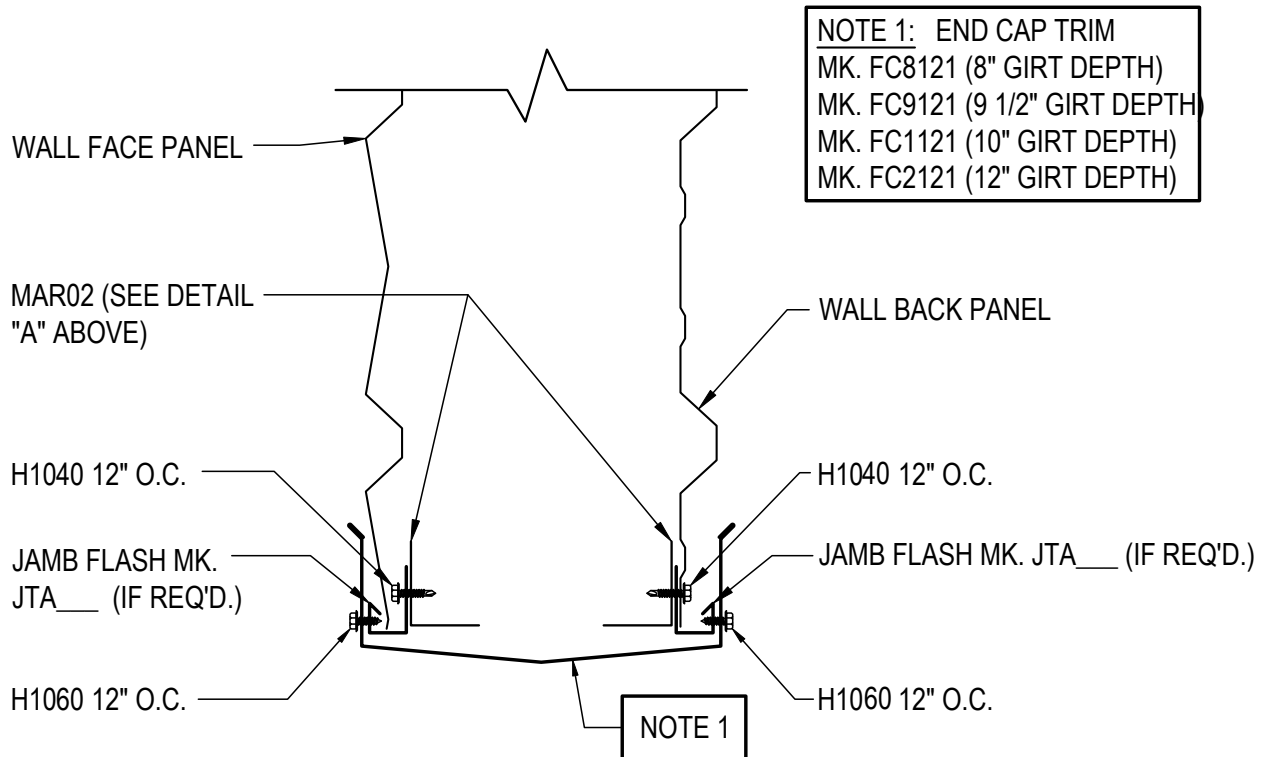

FASCIA TERMINATION SECTION

ABOVE ROOF

HK1090

Detailer Notes:

1) N/A

HK1100 - FASCIA TERMINATION SECTION - REVERSE R-PANEL

[Download the DWG file by clicking here.](#)

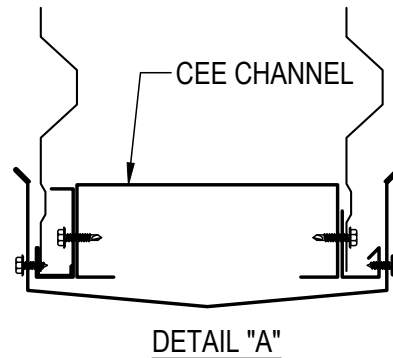

SUPPORT MEMBER MAY BE A CEE CHANNEL IN LIEU OF MAR02 ANGLES. REFER TO FASCIA ELEVATIONS AND FASCIA STRUCTURAL DETAILS.

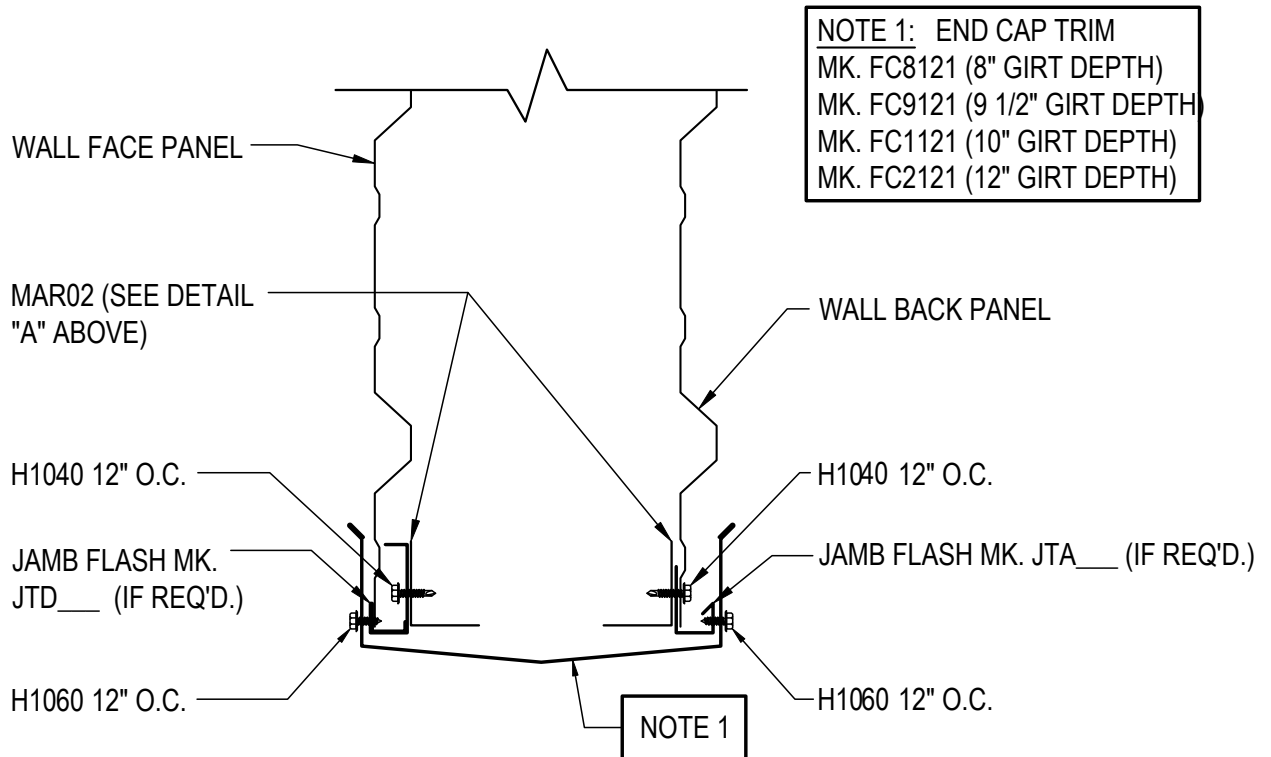

FASCIA TERMINATION SECTION

ABOVE ROOF

HK1100

Detailer Notes:

1) N/A

HK1110 - FASCIA TERMINATION SECTION - R-PANEL

[Download the DWG file by clicking here.](#)

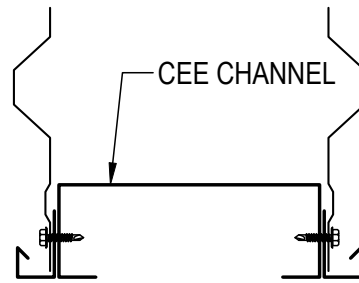

DETAIL "A"

SUPPORT MEMBER MAY BE A CEE CHANNEL IN LIEU OF MAR02 ANGLES. REFER TO FASCIA ELEVATIONS AND FASCIA STRUCTURAL DETAILS.

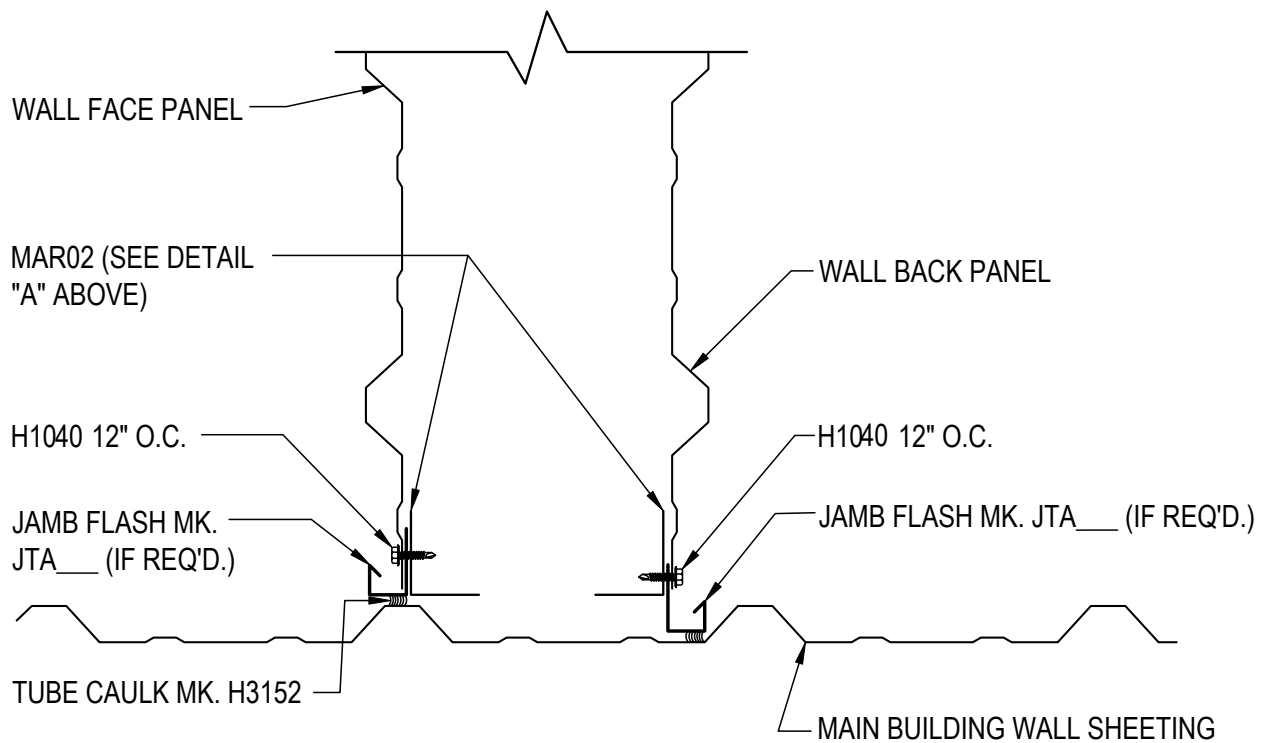

FASCIA TERMINATION SECTION

BELOW ROOF

HK1110

Detailer Notes:

- 1) N/A

HK1120 - FASCIA TERMINATION SECTION - A-PANEL

[Download the DWG file by clicking here.](#)

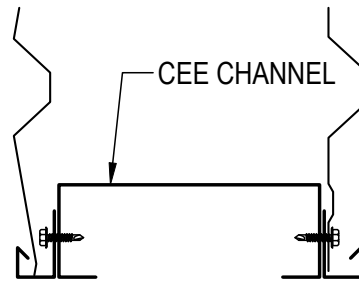

DETAIL "A"

SUPPORT MEMBER MAY BE A CEE CHANNEL IN LIEU OF MAR02 ANGLES. REFER TO FASCIA ELEVATIONS AND FASCIA STRUCTURAL DETAILS.

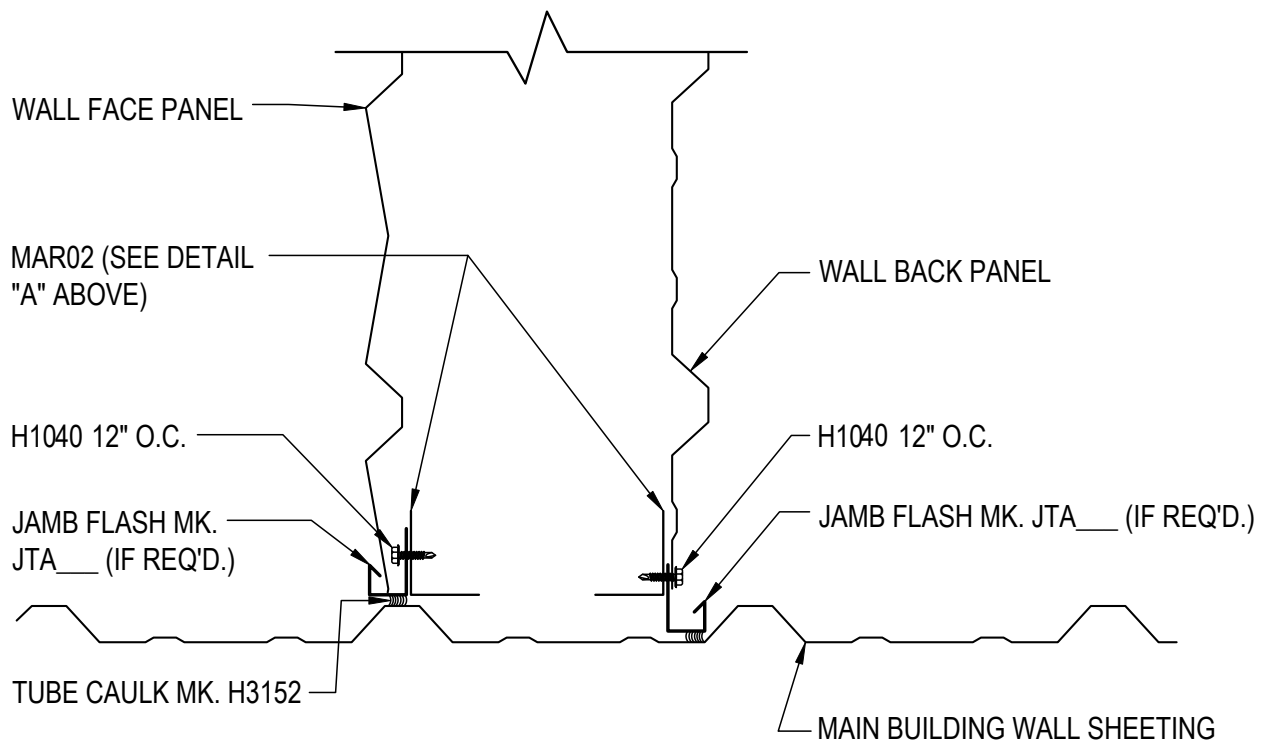

FASCIA TERMINATION SECTION

BELOW ROOF

HK1120

Detailer Notes:

- 1) N/A

HK1130 - FASCIA TERMINATION SECTION - REVERSE R-PANEL

[Download the DWG file by clicking here.](#)

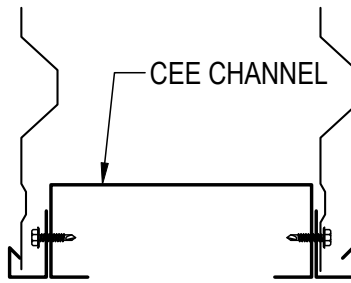

DETAIL "A"

SUPPORT MEMBER MAY BE A CEE CHANNEL IN LIEU OF MAR02 ANGLES. REFER TO FASCIA ELEVATIONS AND FASCIA STRUCTURAL DETAILS.

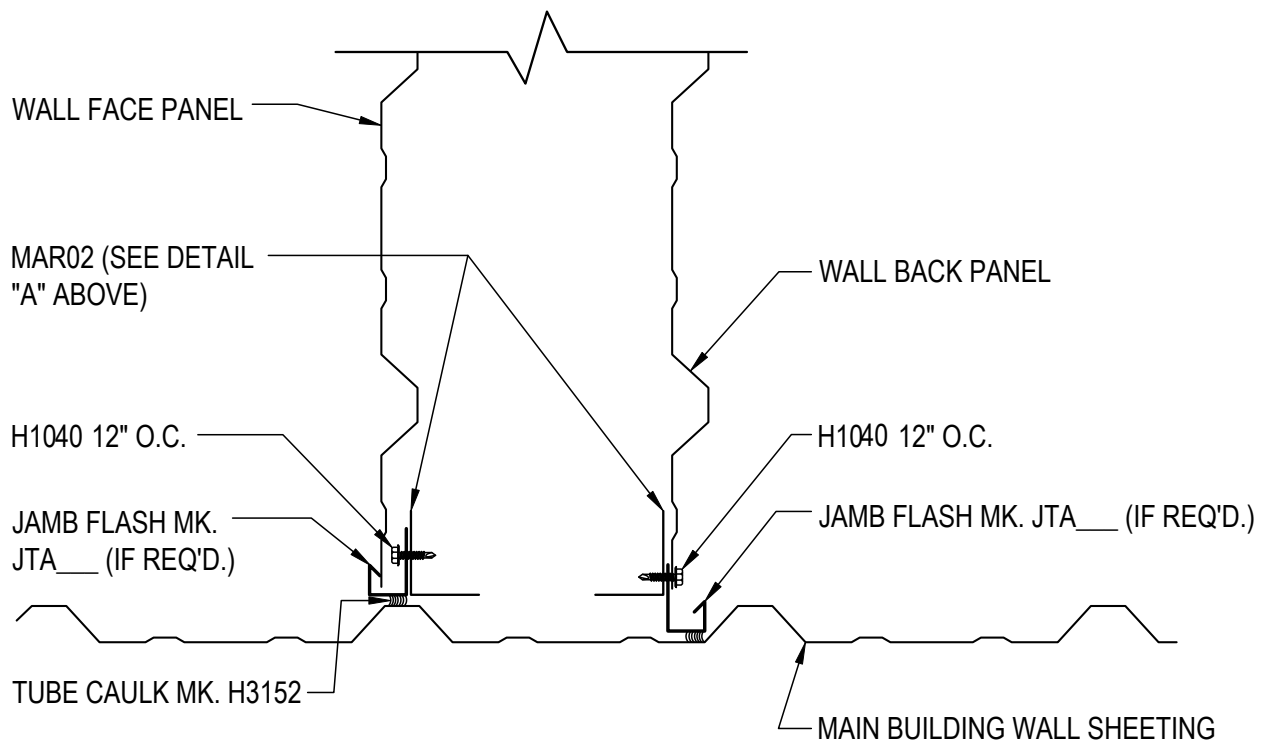

FASCIA TERMINATION SECTION

BELOW ROOF

HK1130

Detailer Notes:

- 1) N/A

HK1140 - SOFFIT CORNER TRIM

[Download the DWG file by clicking here.](#)

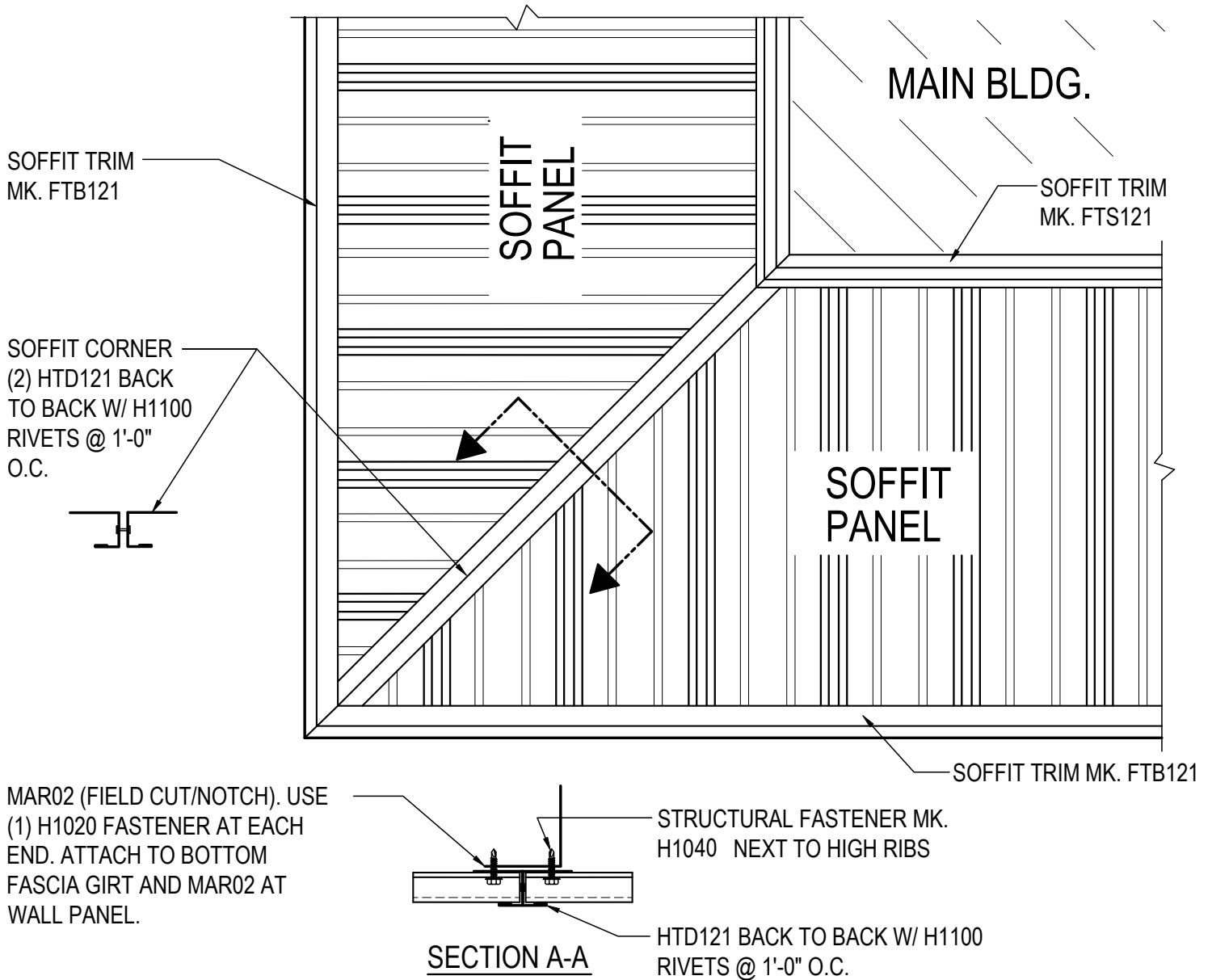

SOFFIT CORNER TRIM

BOTTOM VIEW

HK1140

Detailer Notes:

- 1) N/A

HK1150 - FASCIA CAP TRIM CORNER DETAIL

[Download the DWG file by clicking here.](#)

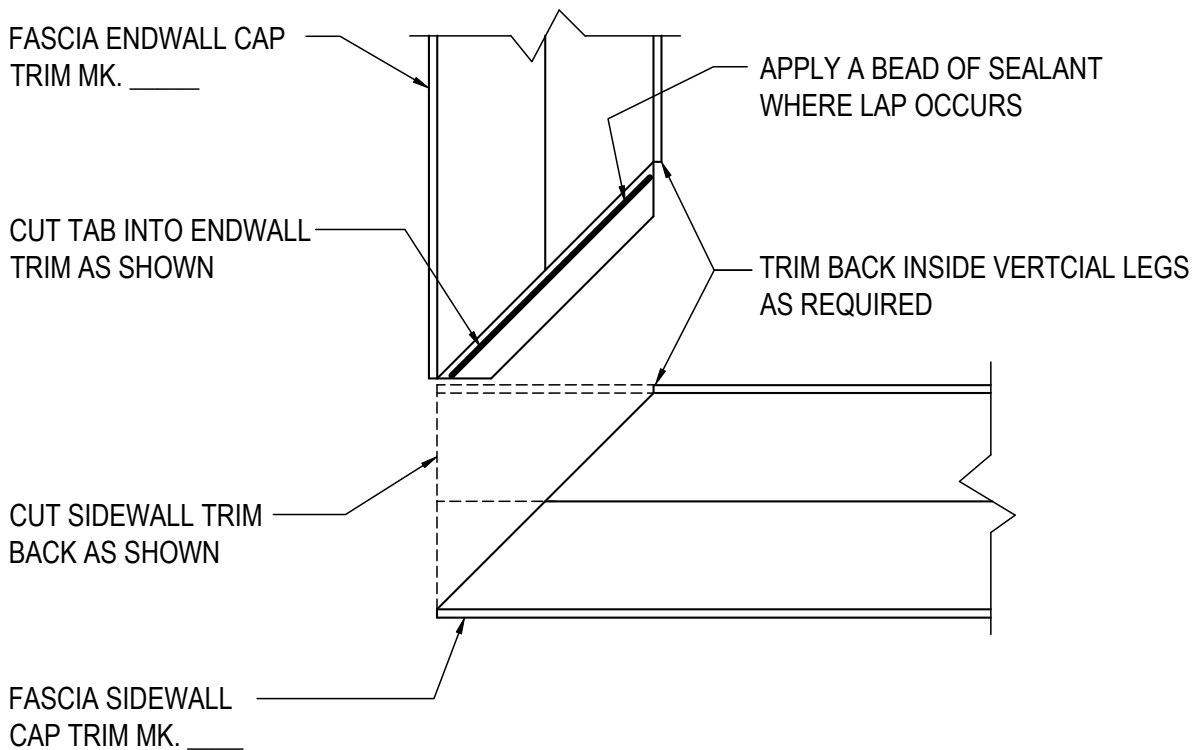
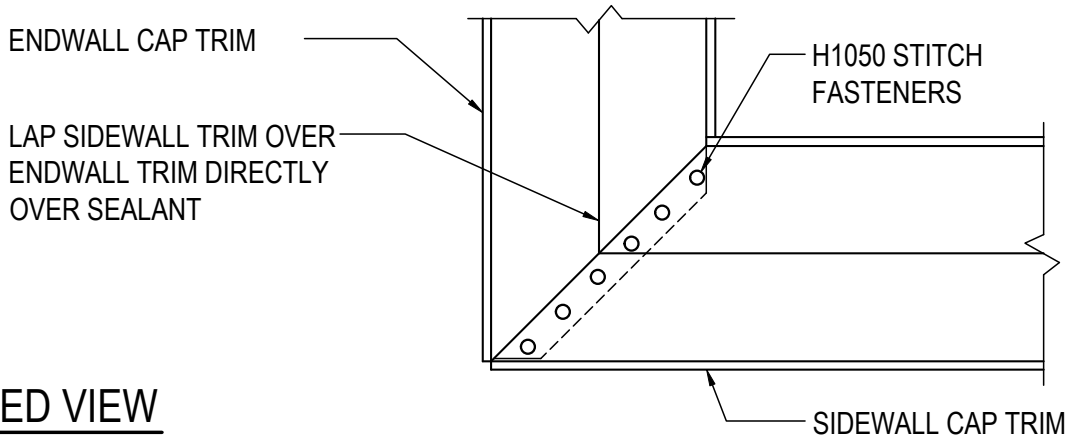

FASCIA CAP TRIM CORNER DETAIL

BOTTOM VIEW

HK1150

Detailer Notes:

- 1) N/A

HK1160 - FASCIA TERMINATION DETAIL

[Download the DWG file by clicking here.](#)

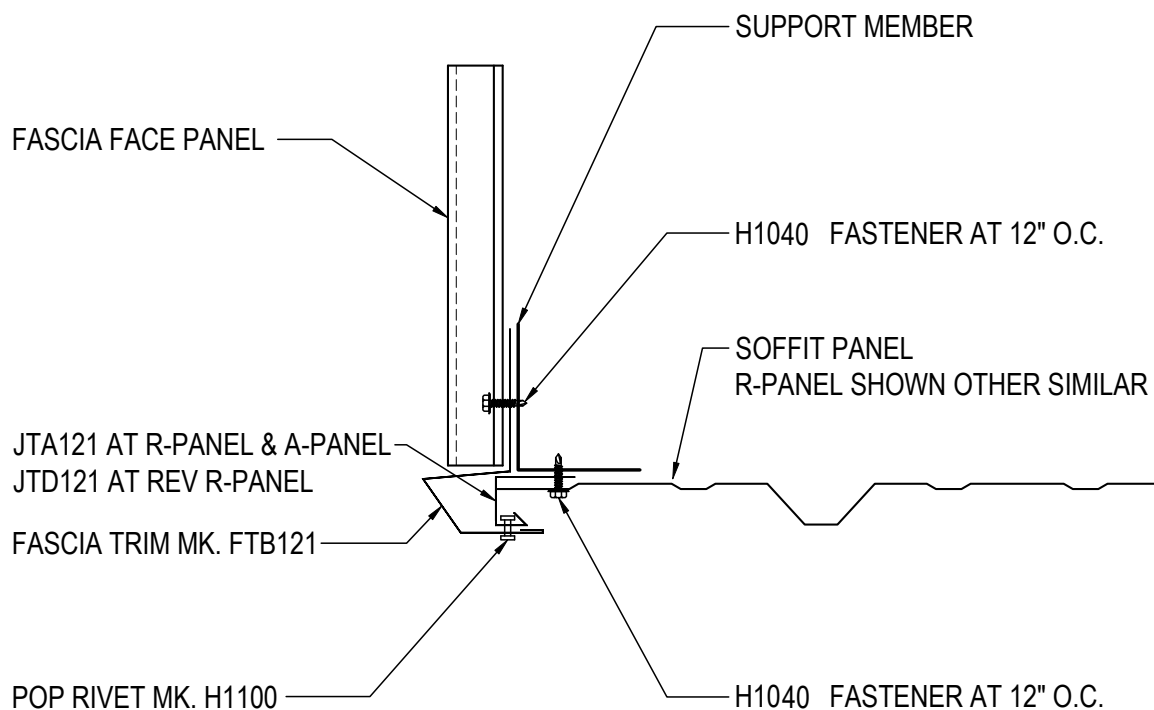

FASCIA TERMINATION

SEE WALL PANEL ERECTION NOTES FOR WALL PANEL FASTENER LOCATIONS
SEE SOFFIT PANEL ERECTION NOTE FOR SOFFIT PANEL FASTENER LOCATIONS

HK1160

Detailer Notes:

1) N/A

HK1170 - FASCIA TERMINATION DETAIL

[Download the DWG file by clicking here.](#)

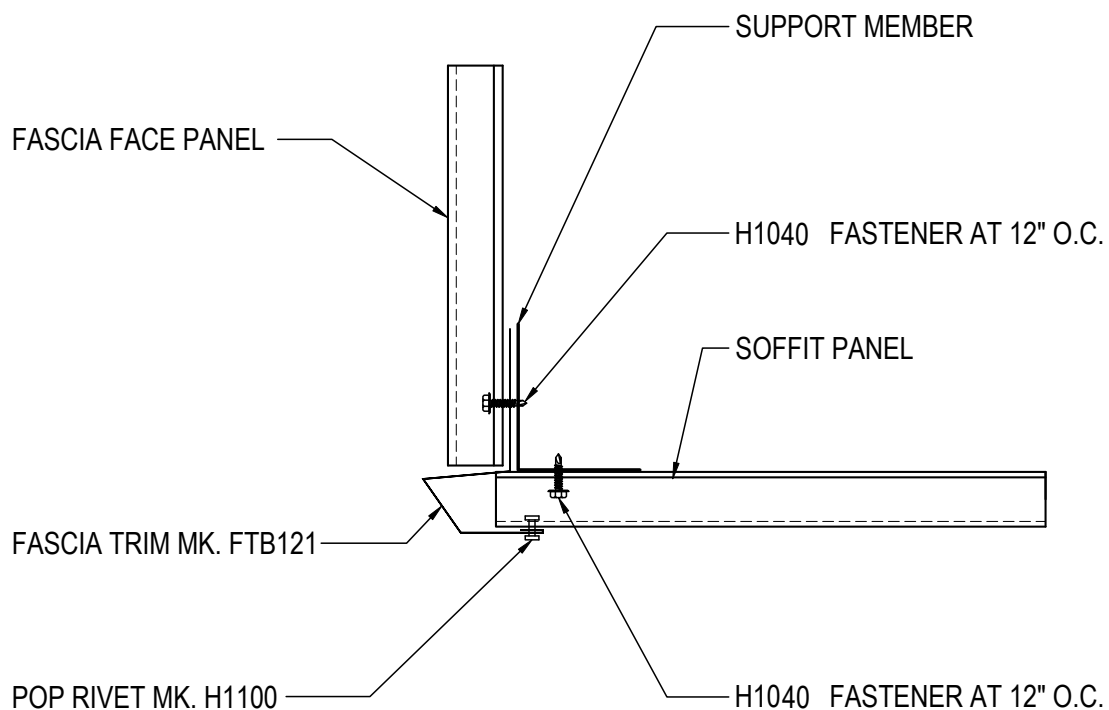

FASCIA TERMINATION

SEE WALL PANEL ERECTION NOTES FOR WALL PANEL FASTENER LOCATIONS
SEE SOFFIT PANEL ERECTION NOTE FOR SOFFIT PANEL FASTENER LOCATIONS

HK1170

Detailer Notes:

1) N/A

HK1180 - FASCIA SOFFIT TERMINATION AT WALL

[Download the DWG file by clicking here.](#)

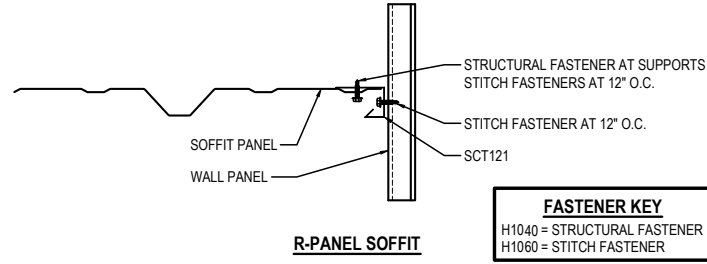
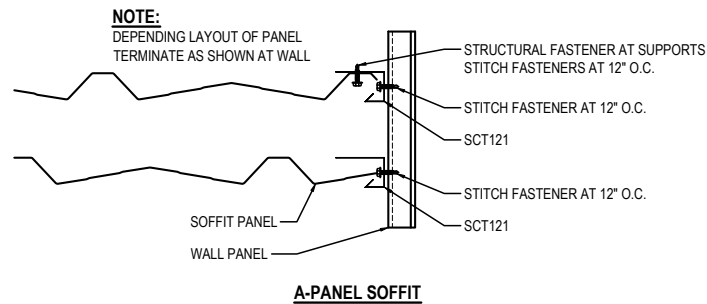
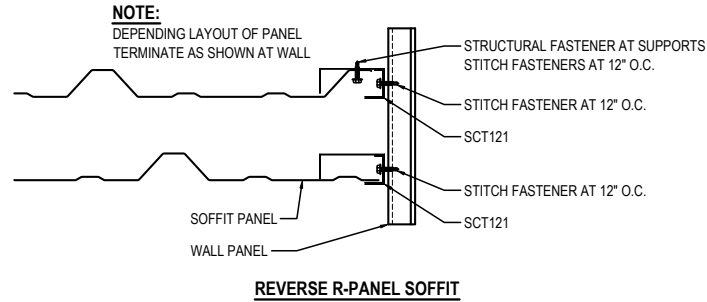

PANEL PARALELL TO WALL

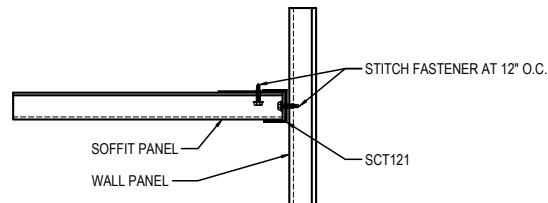

PANEL PERPENDICULA TO WALL

FASCIA SOFFIT TERMINATION AT WALL

SEE WALL PANEL ERECTION NOTES FOR WALL PANEL FASTENER LOCATIONS
SEE SOFFIT PANEL ERECTION NOTE FOR SOFFIT PANEL FASTENER LOCATIONS

HK1180

Detailer Notes:

1) N/A